

PLAN

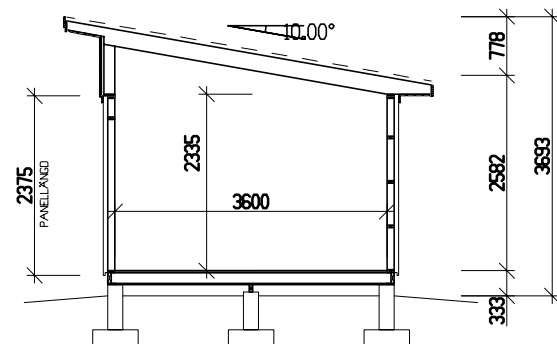

SEKTION

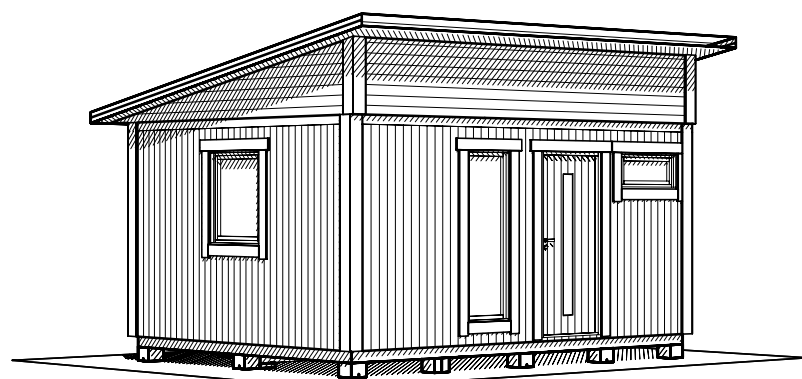

PERSPEKTIV

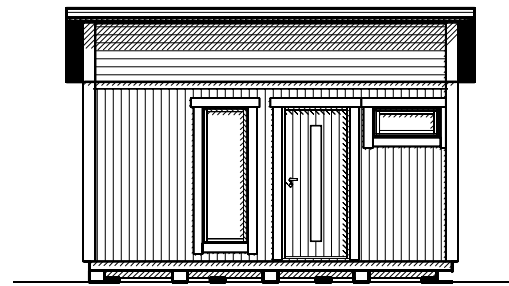
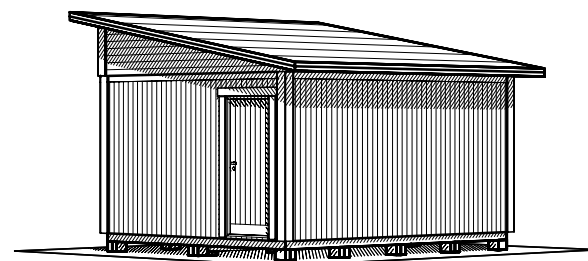

FASAD MOT

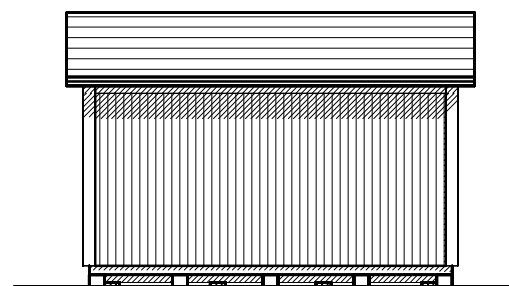

FASAD MOT

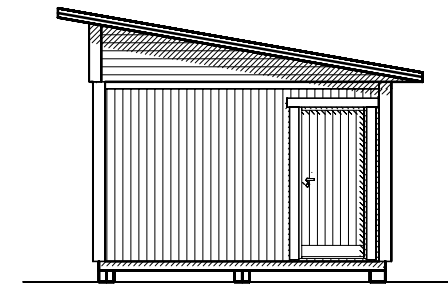

FASAD MOT

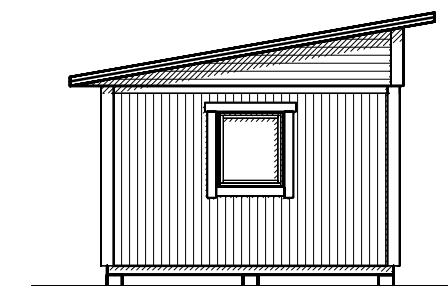

FASAD MOT

PANEL: FUNKISPANEL 22x120.
 STOMME: 34x95.
 OISLERAT.
 BJÄKLÄG 45x145.
 GRUNDLÄGGNING: PLINT GRUND.
 LEVERANSOMFATTNING ENLIGT AVTAL.

BET	ANT	ÄNDRINGEN AVSER	DATUM	SIGN
-----	-----	-----------------	-------	------

BYGGLOVSHANDLING
 NYBYGGNAD AV KOMPLEMENTBYGGNAD



UPPDRAG NR/RITN. NR XXXX	RITAD/KONSTR AV PH
DATUM 2018-11-02	HANDLÄGGARE

PLAN & SEKTION
 NJUTA FUNKIS 20-2

ANSVARIG	SKALA 1:100, A3	NUMMER A01	BET
----------	--------------------	---------------	-----